

# HERMES

REF : HERMES - RGW

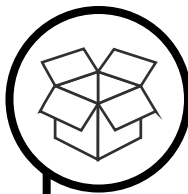

	<b>X 1</b>		<b>X 2</b>		<b>X 8</b>
			<b>X 2</b>		<b>X 8</b>
			<b>X 1</b>		<b>X 4</b>
			<b>X 1</b>		<b>X 8</b>

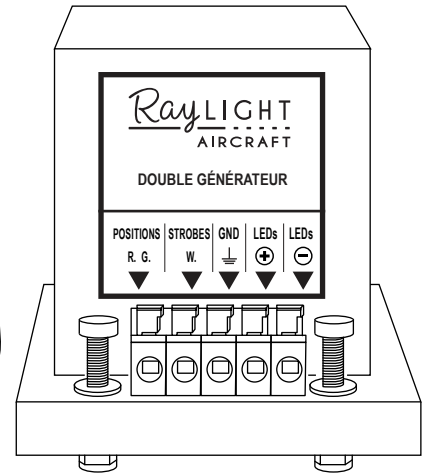
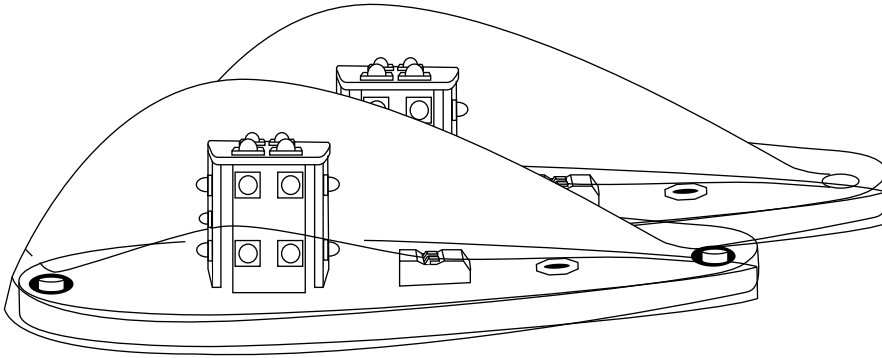

			5,5 mm		
$\varnothing 3,5 \text{ mm}$	$\varnothing 5 \text{ mm}$ → $\varnothing 10 \text{ mm}$	$0,25 \text{ mm}^2$ → $1,5 \text{ mm}^2$ (AWG 16 - 26)	<b>Cockpit option</b>		
	<b>7</b>	<b>8</b>	<b>X 2</b>		

1

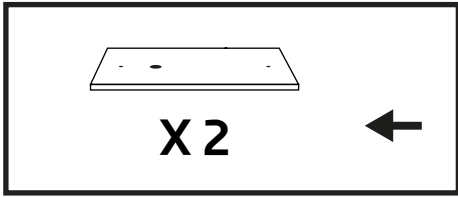
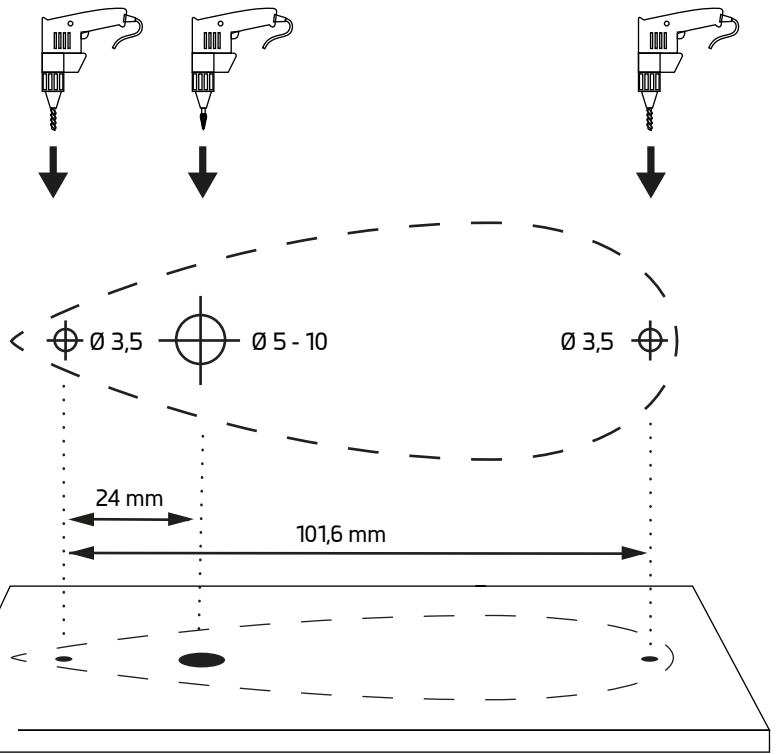
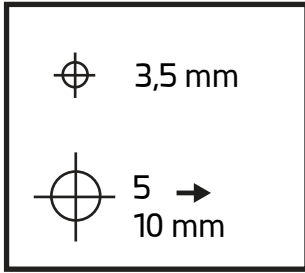
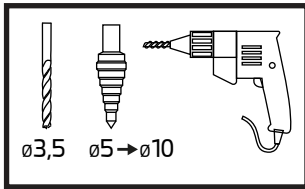

2

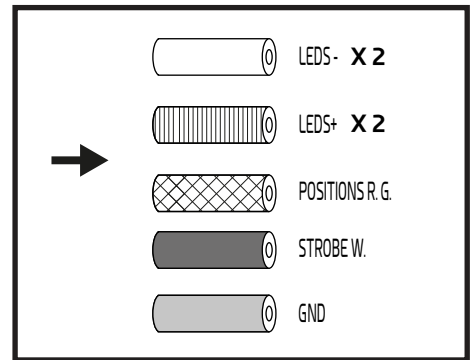
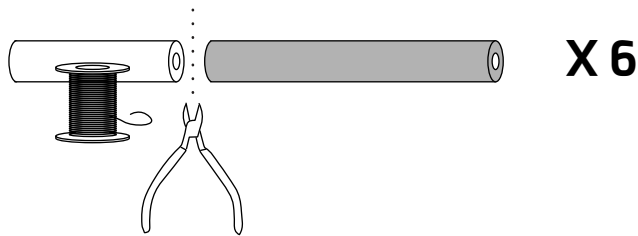
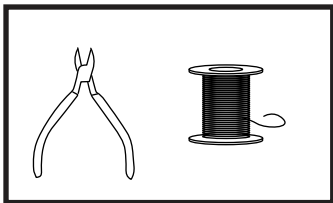

3

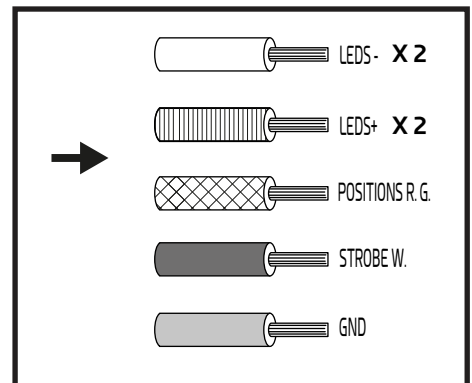
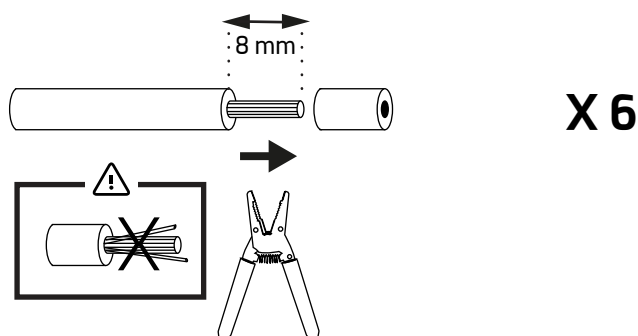
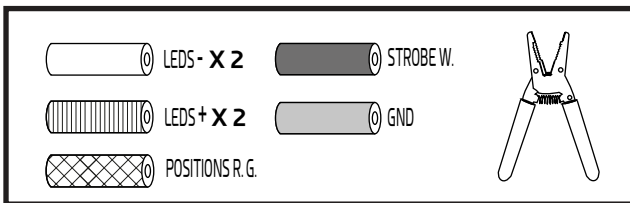

4

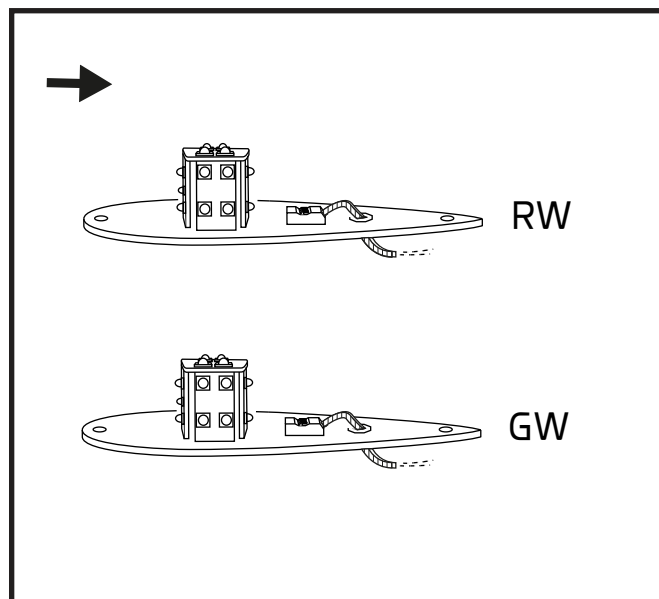
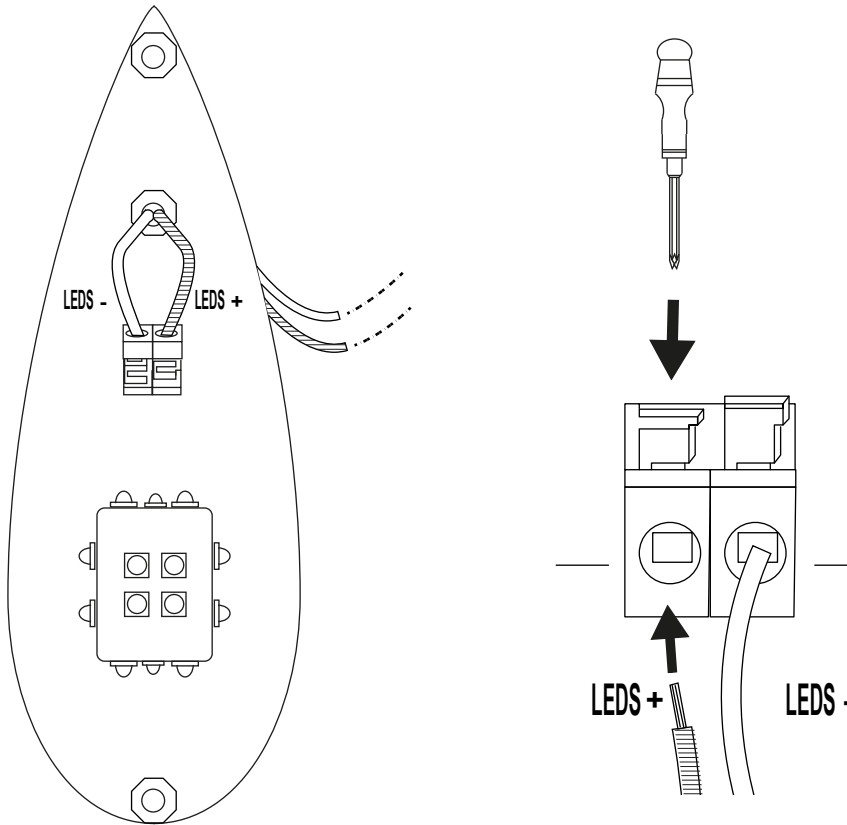
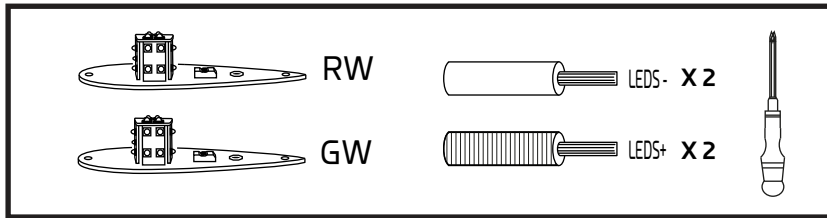

4

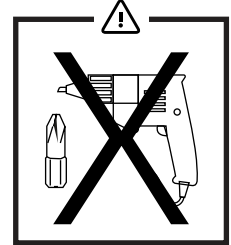
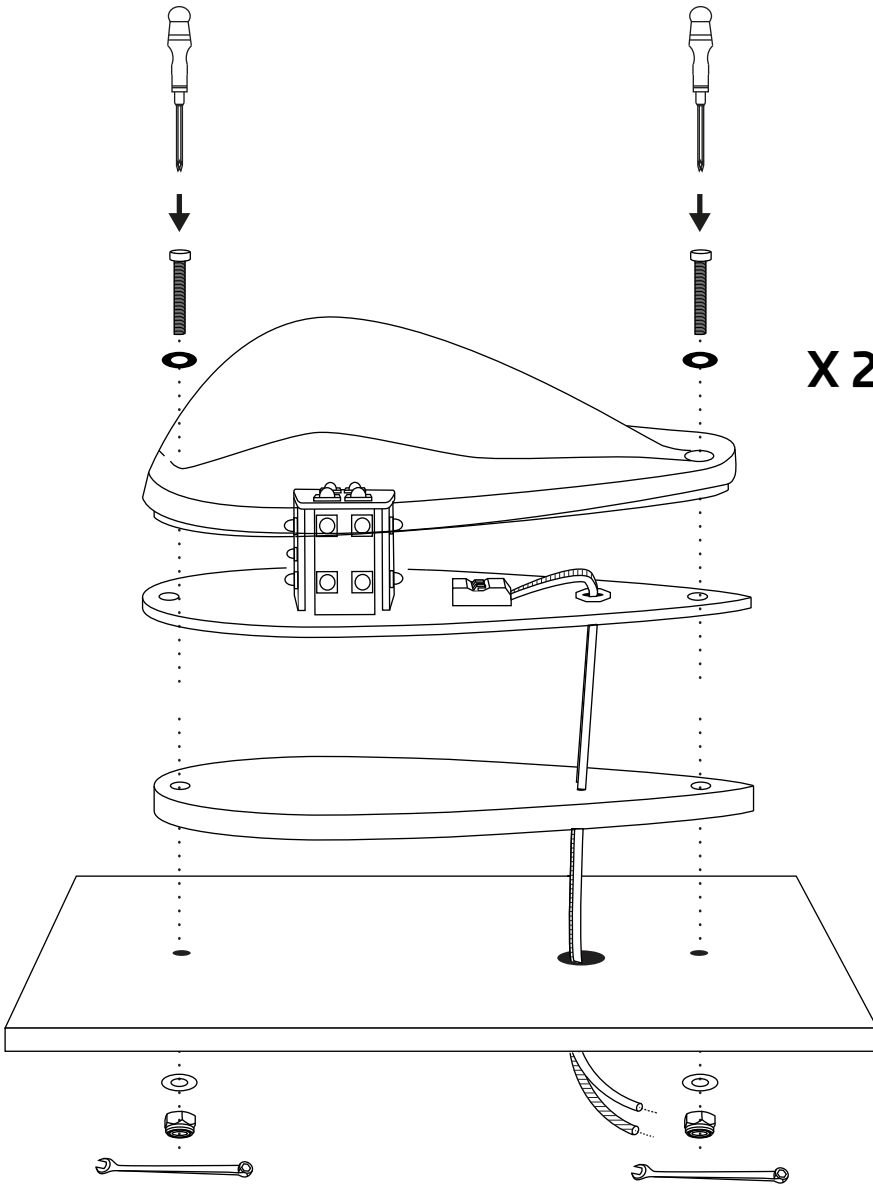
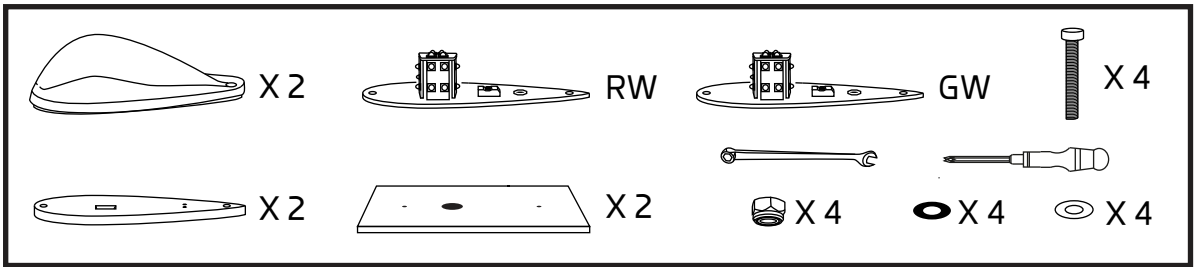

X 2

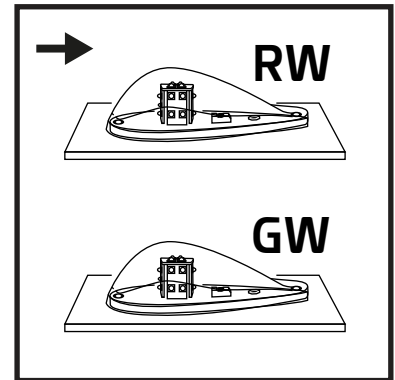

5

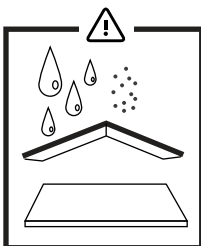
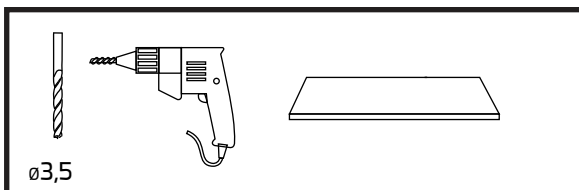

⌀ 3,5 mm

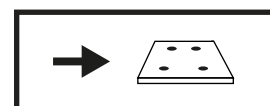
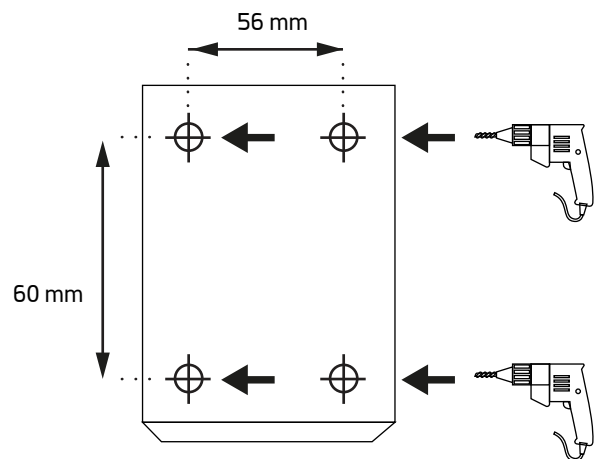

6

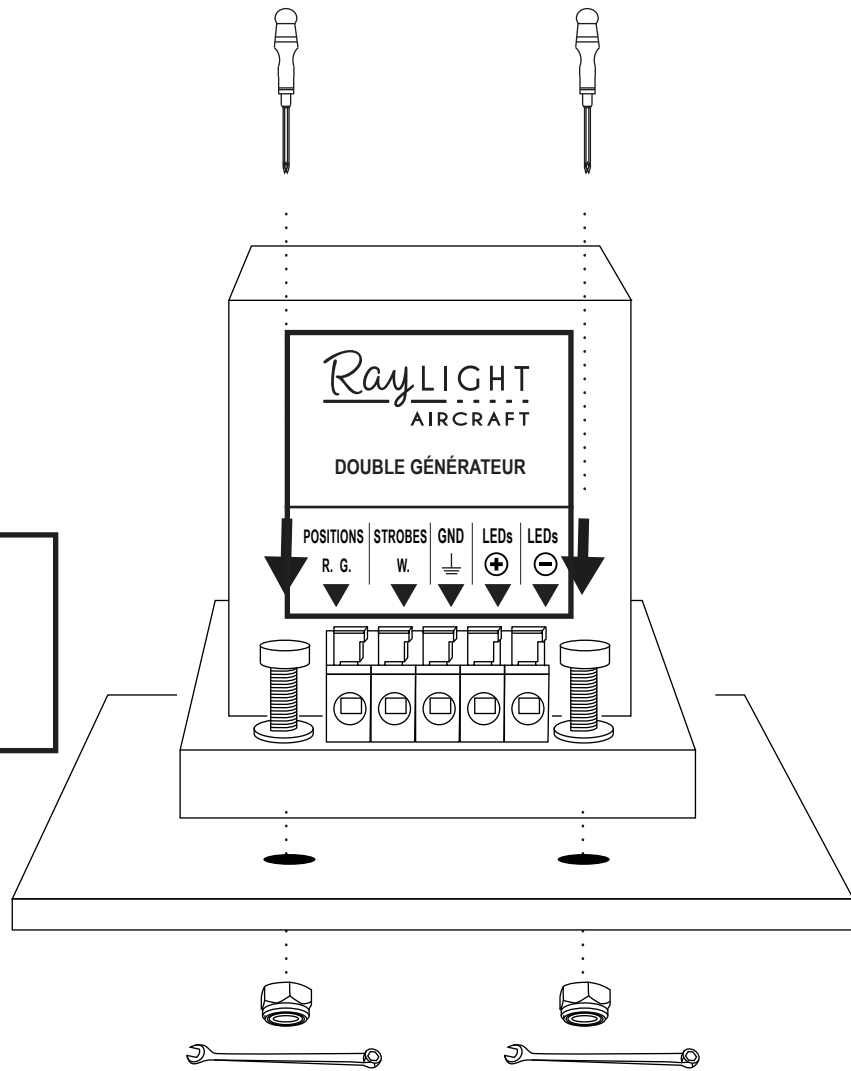
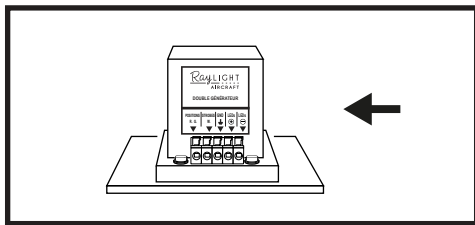
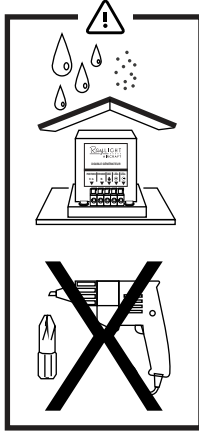
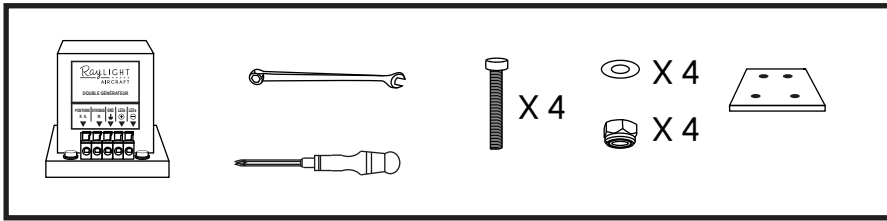

7

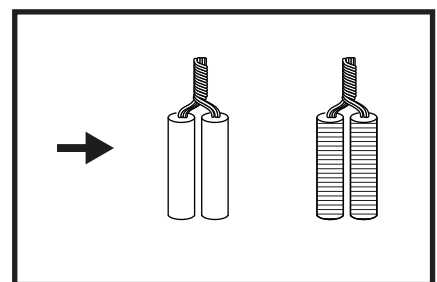
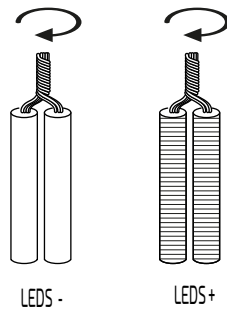
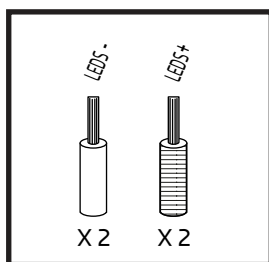

8

